

YDS-M3MA-AR1335 PLCC V15.3

13MP OnSemi AR1335 PLCC MIPI Interface Auto Focus Camera Module



Front View



Back View

Specifications

Camera Module No.	YDS-M3MA-AR1335 PLCC V15.3
Resolution	13MP
Image Sensor	AR1335 PLCC
Sensor Type	1/3.2"
Pixel Size	1.1 um x 1.1 um
EFL	4.35 mm
F.NO	1.90
Pixel	4208 x 3120
View Angle	90.3°(DFOV) 77.4°(HFOV) 62.0°(VFOV)
Lens Dimensions	8.50 x 8.50 x 5.45 mm
Module Size	55.17 x 8.50 mm
Module Type	Auto Focus
Interface	MIPI
Auto Focus VCM Driver IC	FP5510
Lens Type	650nm IR Cut
Operating Temperature	-30°C to +70°C
Mating Connector	DF30FC-30DS-0.4V



YDS-M3MA-AR1335 PLCC V15.3

13MP OnSemi AR1335 PLCC MIPI Interface Auto Focus Camera Module



Top View



Side View



Bottom View

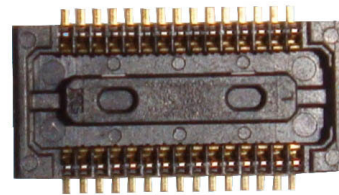

Mating Connector

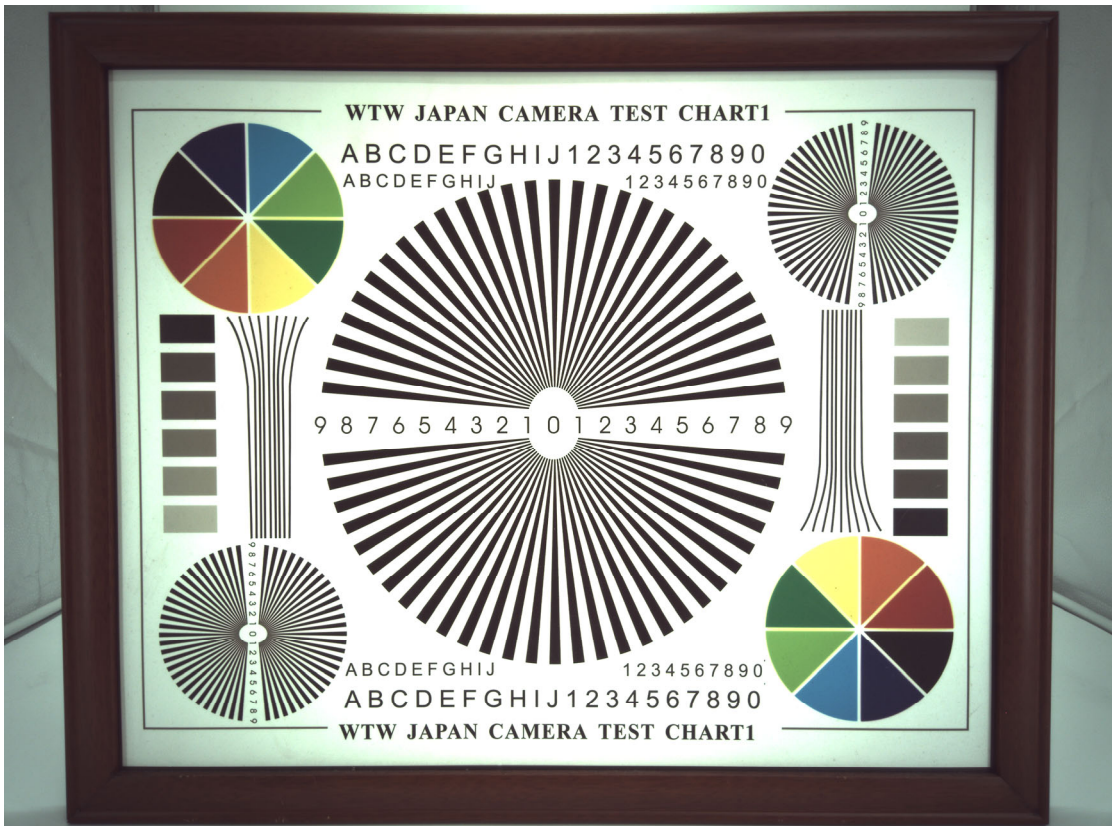

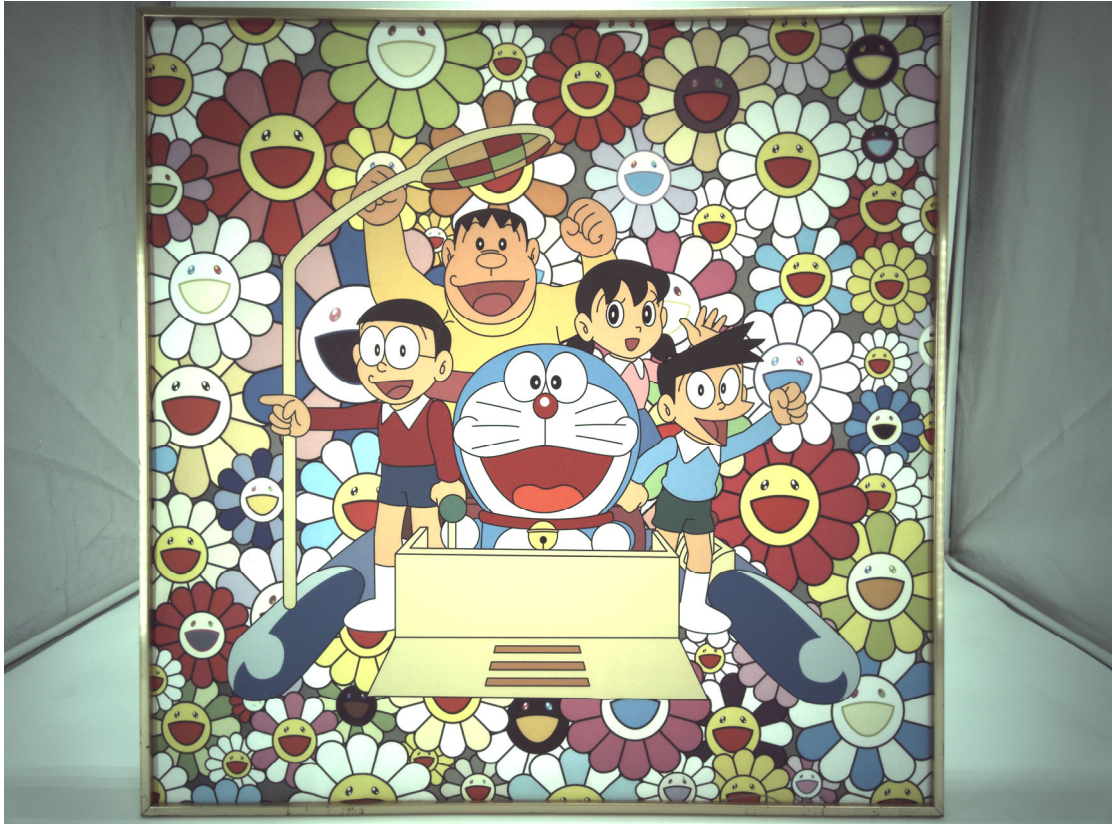

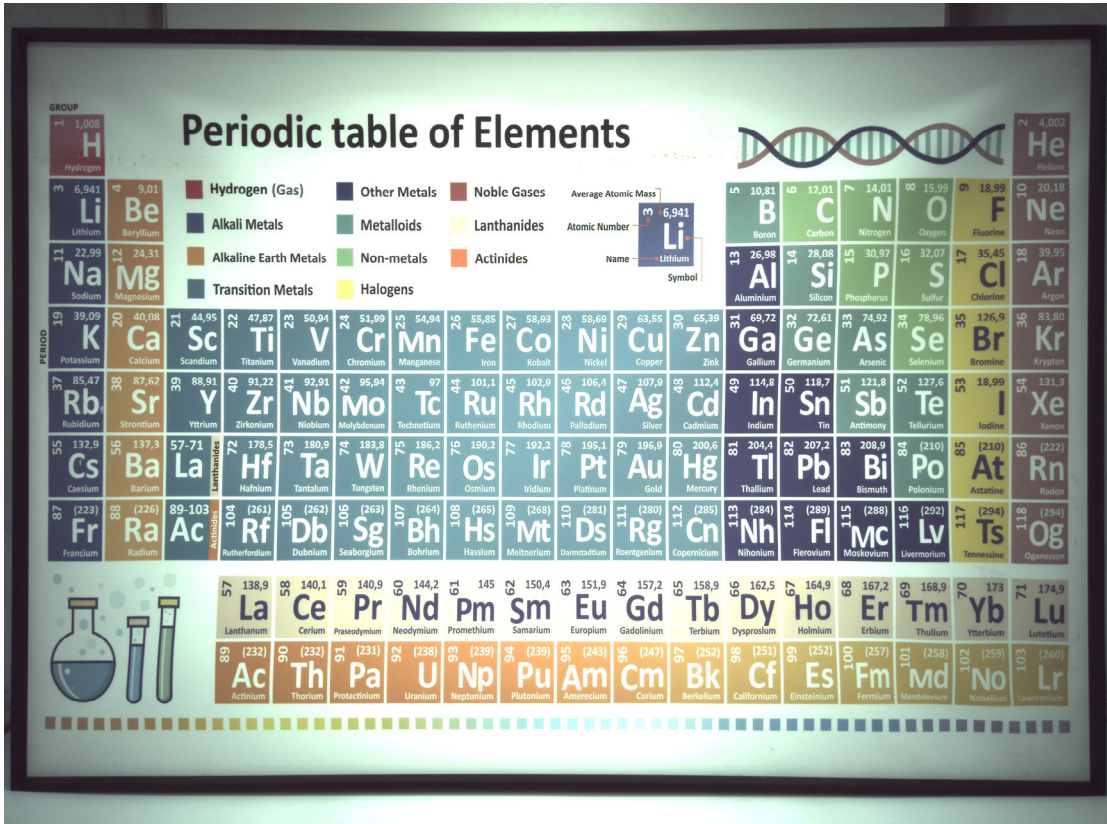

PIN	SIGNAL
1	AFVDD 2.8V
2	NC
3	DVDD 1.2V
4	DOVDD 1.8V
5	NC
6	AGND
7	AVDD 2.8V
8	DGND
9	SDA
10	SCL
11	RESET
12	NC
13	DGND
14	MCLK
15	DGND
16	MDP0
17	MDN0
18	DGND
19	MDP1
20	MDN1
21	DGND
22	MCP
23	MCN
24	DGND
25	MDP2
26	MDN2
27	DGND
28	MDP3
29	MDN3
30	DGND

Version	Information
V1.0	First Version
V2.0	Change PIN signal and connector
V5.0	Change PIN signal and connector position
V12.0	Change capture direction
V15	Extend FPC length
V15.2	Change lens and VCM
V15.3	Add double-sided adhesive

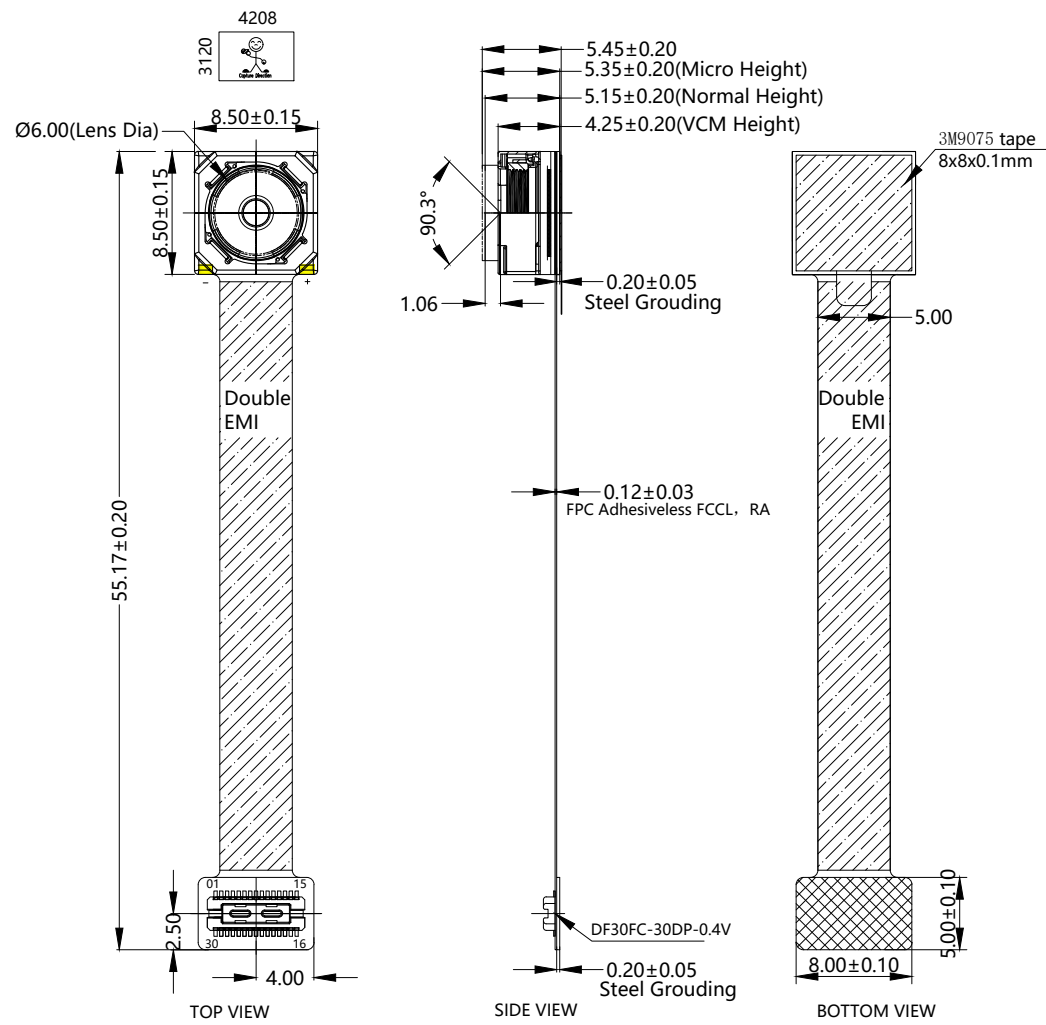

NOTE:
1.The device slave address:0x6C(w);0x6D(r)

Parameter:
1、Sensor specification:
ImageSensor: AR1335C5SC32SMD20
Pixel: 1.1um*1.1um
Lens Type: 1/3.2
Important Voltage Description:
DVDD1.2V (external power supply);

2、Lens specification:
FOV: 90.3°(D);77.4°(H);62°(V)
F/NO.: 1.9
TV distortion: <1.0%
Focal length: 2.8mm
Composition: 5P+IR FILTER
IR Cut Coating: 650nm±10nm@50%

www.YDSCAM.com

Designed By	Kevin	Model Name:	YDS-M3MA-AR1335 PLCC V15.3		
Checked By	Jacky	Projection Type:	Unit:	Date: 11/7/2025	
			mm	Scale:	Sheet: 1 of 1
			1:1		Version: 1/0

Product Overview

AR1335: 13 MP 1/3" CMOS Image Sensor

For complete documentation, see the data sheet.



The AR1335 is a 1/3.2-inch CMOS active-pixel digital image sensor with a pixel array of 4208H x 3120V. The AR1335 digital image sensor, features breakthrough 1.1 μm pixel technology that delivers superior low-light image quality through leading sensitivity, quantum efficiency and linear full well. This allows image quality that rivals digital still cameras. With a sensor architecture focused on low power and a high Chief Ray Angle (CRA) for low Z-heights, the AR1335 is ideal for smartphone and other mobile device applications. It incorporates sophisticated on-chip camera functions such as windowing, mirroring, column and row skip modes, and snapshot mode. It is programmable through a simple two-wire serial interface. The AR1335 sensor can generate full resolution image at up to 30 frames per second (fps) and supports advanced video modes including 4K 30fps, 1080P 60fps and 720P 120fps.

Features

- 13MP CMOS sensor with advanced 1.1 μm pixel BSI technology
 - Data interfaces: 2,3 and 4 lane MIPI
 - Bit-depth compression available for MIPI: 10-8 and 10-6 to lower bandwidth
 - 3D synchronization controls to enable stereo video capture
 - 6.8 kbits one time programmable memory (OTPM)
 - Programmable controls: gain, horizontal and vertical blanking, auto black level offset correction, frame size/rate, exposure, left-right and top-bottom image reversal, window size, and panning
 - Two on-die phase-locked loop (PLL) oscillators for super low noise performance
 - On-chip temperature sensor
 - Bayer pattern horizontal down-size scaler
 - Simple two-wire fast-mode+ serial interface
- For more features, see the data sheet

Applications

- Mobile
- 4K video capture
- High resolution still capture

End Products

- Smart Phone
- Digital Still Camera
- PC Camera
- Consumer devices

Part Electrical Specifications

Product	Compliance	Status	Type	Megapixels	Frame Rate (fps)	Optical Format	Shutter Type	Pixel Size (μm)	Output Interface	Color	Package Type
AR1335CSSC11SMD20	Pb-free Halide free	Active	CMOS	13	30	1/3.2 inch	Electronic Rolling	1.1 x 1.1	MIPI	RGB	
AR1335CSSC11SMKA0-CP	Pb-free Halide free	Active	CMOS	13	30	1/3.2 inch	Electronic Rolling	1.1 x 1.1	MIPI	RGB	ODCSP-63
AR1335CSSC11SMKA0-CR	Pb-free Halide free	Active	CMOS	13	30	1/3.2 inch	Electronic Rolling	1.1 x 1.1	MIPI	RGB	ODCSP-63
AR1335CSSC32SMD20	Pb-free Halide free	Active	CMOS	13	30	1/3.2 inch	Electronic Rolling	1.1 x 1.1	MIPI	RGB	
AR1335CSSM11SMD20	Pb-free Halide free	Active	CMOS	13	30	1/3.2 inch	Electronic Rolling	1.1 x 1.1	MIPI	RGB	
AR1335CSSM32SMD20	Pb-free Halide free	Active	CMOS	13	30	1/3.2 inch	Electronic Rolling	1.1 x 1.1	MIPI	RGB	

Application Diagram



For connectivity above:

- Notes:
- All power supplies should be adequately decoupled; recommended cap values are:
 - 2.7V: 1.0μF and 0.1μF
 - 1.2V: 1.0μF and 0.1μF
 - 1.8V: 1.0μF and 0.1μF
 - Resistor value 1.5kΩ is recommended, but may be greater for slower two-wire speed.
 - This pull-up resistor is not required if the controller drives a valid logic level on SCLK at all times.
 - V_{AA} and V_{AA_PIX} must be tied together.
 - Internal charge pump is used for OTPM programming.
 - Digital and MIPI supply can be tied together.
 - ATEST1/AATEST2 must be left floating.
 - TEST pin must be tied to D_{GND}.
 - V_{DD_SLVS} must be connected to D_{GND} through a bypass cap (0.1μF).

For more information please contact your local sales support at www.onsemi.com.

Created on: 9/30/2017



1/3.2-Inch 13 Mp CMOS Digital Image Sensor

AR1335 Datasheet, Rev. A

For the latest datasheet, please visit: www.aptna.com

Features

- 13 Mp CMOS sensor with advanced 1.1 μm pixel BSI technology
- Data interfaces: two-, three-, and four-lane serial mobile industry processor interface (MIPI)
- Bit-depth compression available for MIPI Interface: 10-8 and 10-6 to enable lower bandwidth receivers for full frame rate applications
- 3D synchronization controls to enable stereo video capture
- 6.8 kbits one-time programmable memory (OTPM) for storing shading correction coefficients and module information
- Programmable controls: gain, horizontal and vertical blanking, auto black level offset correction, frame size/rate, exposure, left-right and top-bottom image reversal, window size, and panning
- Two on-die phase-locked loop (PLL) oscillators for super low noise performance
- On-chip temperature sensor
- Bayer pattern horizontal down-size scaler
- Simple two-wire fast-mode+ serial interface
- Low dark current
- Interlaced multi-exposure readout enabling High Dynamic Range (HDR) still and video applications
- On-chip lens shading correction
- Support for external mechanical shutter
- Support for external LED or Xenon Flash
- Extended Flash duration up to start of frame readout

Applications

- Cellular phones
- Digital still cameras
- PC cameras
- PDAs

Table 1: Key Performance Parameters

Parameter	Value	
Optical format	1/3.2 -inch 13 Mp (4:3)	
Active pixels	4208H x 3120V	
Pixel size	1.1 μm Back Side Illuminated (BSI)	
Chief ray angle (CRA)	32°	
Die size	6.3 mm x 5.7 mm	
Input clock frequency	6 - 48 MHz	
Interface	4-lane MIPI (2- and 3-lane supported); Max data rate: 1.2Gbps/lane	
Subsampling modes (column and row)	skip2 bin2 skip3 bin3 skip4 bin4 skip2bin2	
ADC resolution	10 bits, on-die	
Analog gain	1x – 7.75x	
Digital gain	Up to 7.98x	
Scaler	Adjustable scaling up to 8x	
Temperature sensor	10-bit, controlled by two-wire serial I/F	
Compression	DPCM: 10-8-10, 10-6-10	
3D support	Frame rate and exposure synchronization	
Supply voltage	VAA, VAA_PIX	2.6 - 2.9 V (2.7 V nominal)
	VDD_IO, VDDIO_ANA	1.7 - 1.9 V (1.8 V nominal)
	VDD, VDD_ANA, VDD_PLL, VDD_PHY	1.14 - 1.3 V (1.2 V nominal)
Power consumption	270 mW at 60°C (TYP) at 13 Mp 30 fps	
Responsivity	4700 e ⁻ /lux-sec	
SNRMAX	37 dB	
Dynamic Range	69 dB	
Operating Temperature Range (at junction) - Tj	-30°C to +70°C	

**Table 2: Mode of Operation and Power**

Mode	Resolution	Readout Configuration	HFOV	FPS	Power Consumption [mW]
4:3 Snapshot Mode					
13 M full resolution	4208x3120	13M full mode	100%	30	270
13 M full resolution	4208x3120	13M full mode	100%	24	250
VGA	640 x 480	Crop+Subsampling+Scaling	61%	120	190
QVGA	320 x 240	Crop+Subsampling+Scaling	30%	240	165
16:9 Video Mode 30 FPS					
4K UHD	3840 x 2160	Cropping	91%	30	230
4K Cinema	4096 x 2160	Cropping	97%	30	235
1080p	1920 x 1080	Crop+Subsampling+Scaling	91%	30	160
1080p LP	1920 x 1080	Crop+Subsampling+Scaling	91%	30	135
720p	1280 x 720	Crop+Subsampling+Scaling	91%	30	140
16:9 Video Mode 60 FPS					
1080p	1920 x 1080	Crop+Subsampling+Scaling	91%	60	210
1080p LP	1920 x 1080	Crop+Subsampling+Scaling	91%	60	180
720p	1280 x 720	Crop+Subsampling+Scaling	91%	60	175
3M 30 FPS					
3M	2000 x 1500	Crop+Subsampling+Scaling	95%	30	195
3M LP	2000 x 1500	Crop+Subsampling+Scaling	95%	30	170
16:9 Video Mode 120 FPS					
720p	1280 x 720	Crop+Subsampling+Scaling	91%	120	260

Ordering Information

Table 3: Available Part Numbers

Part Number	Description
AR1335C5SC32SMD20	Bare die

10-Bit DAC 120mA VCM Driver with I²C Interface

Description

The FP5510 is a single 10-bit DAC with 120mA output current voice coil motor (VCM) driver, with an I²C-compatible serial interface that operates at clock rates up to 400kHz. Its supply operates from 2.3V to 3.6V.

The FP5510 incorporates with a power-on reset circuit, power-down function. Power-on reset circuit ensure when supply power up, DAC output is to 0V until valid write bit value takes place. In power down mode, the supply current is about 1µA.

The FP5510 is designed for auto focus operation includes digital camera module, optical zoom camera phones and lens auto focus. The I²C address of FP5510 is 0x18h.

The FP5510 with WLCSP package which it is suitable for reduced-space mounting in mobile phone and other portable applications.

Pin Assignments

6-Ball WLCSP

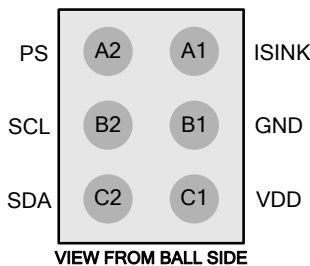

Figure 1. Pin Assignment of FP5510

Features

- Power Supply Voltage Rang: 2.3V to 3.6V
- VCM Driver for Auto-Focus
- 10-Bit Resolution Current Sinking of 120mA for VCM
- 2-Wire I²C Interface (1.8V Interface Compatible)
- Internal 4 Slope Control Mechanism
 1. Enhance Slope Control Mode
 2. One Step Mode
 3. Linear Slope Mode
 4. Two Step Slope Mode
- Power-Save Mode Current < 1µA
- Power On Reset (POR)
- Small Size: 0.7mm×1.1mm (6-Balls WLCSP)

Applications

- Digital Camera Module
- Cell Phone
- Lens Cover
- Web Camera

Ordering Information

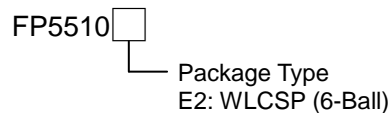

WLCSP-6 (0.7mm×1.1mm) Marking

Part Number	Product Code
FP5510E2	2

0.4 mm Pitch, 0.9 mm Height, Board-to-Board / Board-to-FPC Connectors

DF30 Series

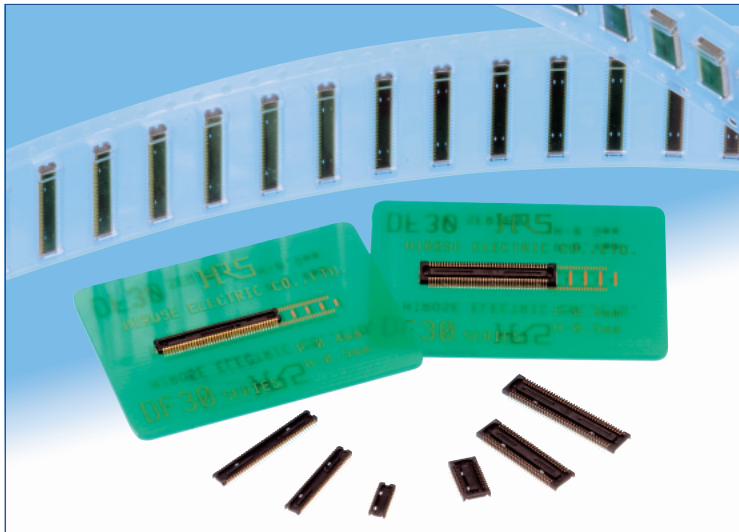

Extremely small size

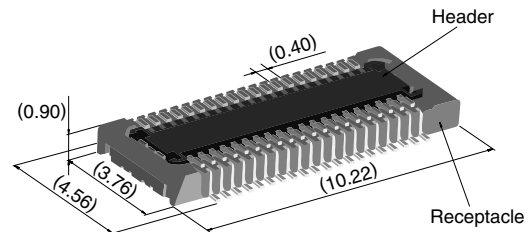

40 positions shown

Overview

Continuous miniaturization and increased component density on PCB created demand for extremely low profile connectors. This series is addition of a new extremely low profile connectors to Hirose's wide range of high reliability board-to-board/board-to-FPC connection solutions.

Features

1. Contact reliability

Concentration of the contact's normal forces at the single point assures good contact wipe and electrical reliability, while confirming the fully mated condition with a definite tactile click.

2. Self alignment

Recognizing the difficulties of mating extremely small connectors in limited spaces the connectors will self align in horizontal axis within 0.3 mm.

3. Automatic board placement

Packaged on tape-and-reel the plug and headers have sufficiently large flat areas to allow pick-up with vacuum nozzles of automatic placement equipment.

4. Variety of contact positions and styles

Available in standard contact positions of: 20, 22, 24, 30, 34, 40, 50, 60, 70 and 80 with and without metal fittings. Addition of metal fittings does not affect external dimensions of the connectors.

Smaller contact positions are also available.

5. Support for continuity test connector

Connectors which have increased insertion and removal durability are available for continuity tests. Contact your Hirose sales representative for details.

Applications

Cellular phones, PDA's, mobile computers, digital cameras, digital video cameras, and other devices demanding high reliability connections in extremely limited spaces.

Low profile

Increased mated retention

High contact reliability

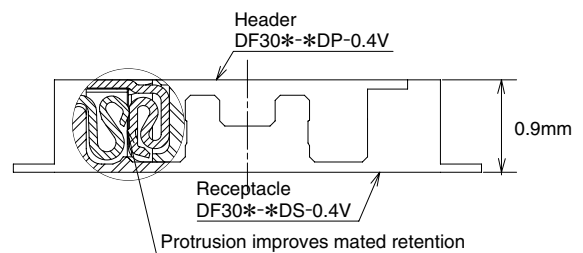

Self alignment

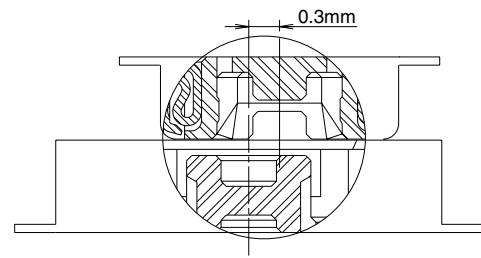

Product Specifications

Rating	Rated current 0.3A	Operating temperature range : -35°C to 85°C (Note 1)	Storage temperature range -10°C to 60°C (Note 2)
	Rated voltage 30V AC	Operating humidity range : Relative humidity 20% to 80%	Storage humidity range Relative humidity 40% to 70% (Note 2)

Item	Specification	Conditions
1. Insulation resistance	50 MΩ min.	100V DC
2. Withstanding voltage	No flashover or insulation breakdown.	100V AC / one minute
3. Contact resistance	100 mΩ max.	100 mA
4. Vibration	No electrical discontinuity of 1 μs or more	Frequency: 10 to 55 Hz, single amplitude of 0.75mm, 2 hours, 3 axis
5. Humidity	Contact resistance: 100 mΩ max. Insulation resistance: 25 MΩ min.	96 hours at temperature of 40°C±2°C and RH of 90% to 95%
6. Temperature cycle	Contact resistance: 100 mΩ max. Insulation resistance: 50 MΩ min.	Temperature: -55°C→+5°C to +35°C→+85°C→+5°C to +35°C Duration: 30→10→30→10(Minutes) 5 cycles
7. Durability (insertions/withdrawals)	Contact resistance: 100 mΩ max.	50 cycles(Connector for conductivity tests: 500 cycles)
8. Resistance to soldering heat	No deformation of components affecting performance.	Reflow: At the recommended temperature profile Manual soldering: 300°C for 3 seconds

Note 1: Includes temperature rise caused by current flow.

Note 2: The term "storage" refers to products stored for long period of time prior to mounting and use. Operating temperature range and humidity range covers non-conducting condition of installed connectors in storage, shipment or during transportation.

Materials and Finishes

Connectors	Component	Material	Finish	Remarks
Receptacles and Headers	Insulator	LCP	Color : Black	UL94V-0
	Contacts	Phosphor bronze	Gold plated	————
	Metal fittings	Phosphor bronze	Tin-copper plated	————

Ordering information

Receptacles and Headers

DF30 FC - * DS - 0.4 V (**)
 ① ② ③ ④ ⑤ ⑥ ⑦

① Series name: DF30	⑤ Contact pitch: 0.4 mm
② Configuration FB: With metal fittings, without bosses FC: Without metal fittings, without bosses CJ: Connector for conductivity tests	⑥ Termination section V: Straight SMT
③ Number of positions: 20, 22, 24, 30, 34, 40, 50, 60, 70, 80	⑦ Packaging (81): Embossed tape packaging (5,000 pieces per reel) (82): Embossed tape packaging (1,000 pieces per reel)
④ Connector type DS: Double row receptacle DP: Double row header	

■ Receptacles (without metal fittings)

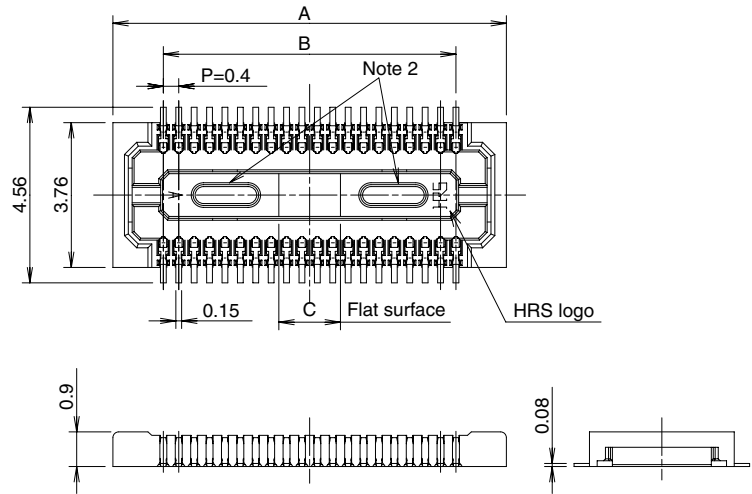
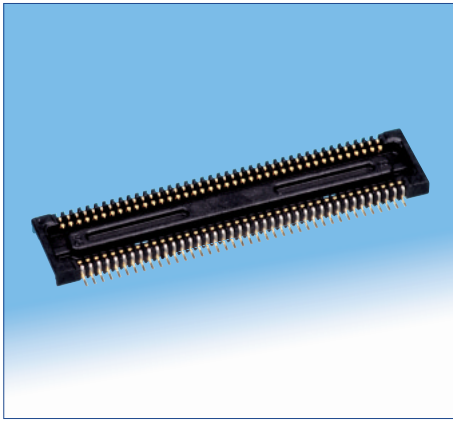

◆ Recommended PCB mounting pattern

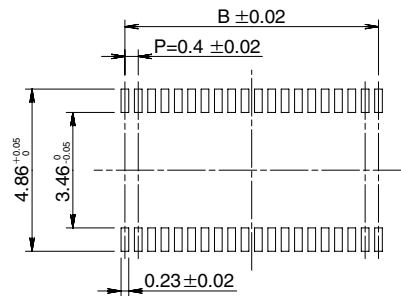

Recommended solder paste thickness: 120 μm

[Specification number] -**, (**)
(81): Embossed tape packaging (5,000 pieces per reel)

* Tolerances non- accumulative.

Unit: mm

Part Number	CL No.	Number of contacts	A	B	C
DF30FC-20DS-0.4V(**)	CL684-1109-8-**	20	6.22	3.6	1.2
DF30FC-22DS-0.4V(**)	CL684-1110-7-**	22	6.62	4.0	1.2
DF30FC-24DS-0.4V(**)	CL684-1111-0-**	24	7.02	4.4	1.2
DF30FC-30DS-0.4V(**)	CL684-1112-2-**	30	8.22	5.6	1.2
DF30FC-34DS-0.4V(**)	CL684-1113-5-**	34	9.02	6.4	1.36
DF30FC-40DS-0.4V(**)	CL684-1078-6-**	40	10.22	7.6	1.6
DF30FC-50DS-0.4V(**)	CL684-1114-8-**	50	12.22	9.6	2.0
DF30FC-60DS-0.4V(**)	CL684-1082-3-**	60	14.22	11.6	2.4
DF30FC-70DS-0.4V(**)	CL684-1115-0-**	70	16.22	13.6	2.8
DF30FC-80DS-0.4V(**)	CL684-1116-3-**	80	18.22	15.6	3.2

Note 1: Order by number of reels.

Note 2: Receptacles with 24 or fewer contacts positions will not have recessed areas.

Cameras Applications



Automotive Driver Pilot



Live Streaming



Video Conference



Eye Tracker Biometric Detection

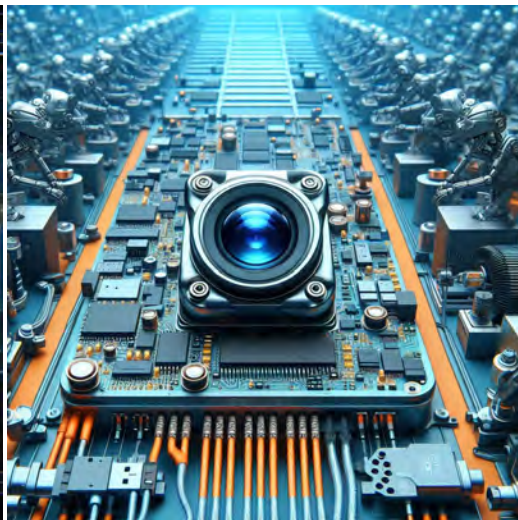

Machine Vision



Agricultural Monitor



Night Vision Security



Drone and Sports Eagle Eyes



Interactive Pet Camera



YDS CAMERA MODULE

your best camera partner

Camera Module Pinout Definition Reference Chart

OmniVision	Sony	Samsung	On-Semi	Aptina	Himax	GalaxyCore	PixArt	SmartSens	Sensors
Pin Signal		Description							
DGND	GND	ground for digital circuit							
AGND		ground for analog circuit							
PCLK	DCK	DVP PCLK output							
XCLR	PWDN	XSHUTDOWN	STANDBY	power down active high with internal pull-down resistor					
MCLK	XVCLK	XCLK	INCK	system input clock					
RESET	RST	reset active low with internal pull-up resistor							
NC	NULL	no connect							
SDA	SIO_D	SIOD	SCCB data						
SCL	SIO_C	SIOC	SCCB input clock						
VSYNC	XVS	FSYNC	DVP VSYNC output						
HREF	XHS	DVP HREF output							
DOVDD	power for I/O circuit								
AFVDD	power for VCM circuit								
AVDD	power for analog circuit								
DVDD	power for digital circuit								
STROBE	FSTROBE	strobe output							
FSIN	synchronize the VSYNC signal from the other sensor								
SID	SCCB last bit ID input								
ILPWM	mechanical shutter output indicator								
FREX	frame exposure / mechanical shutter								
GPIO	general purpose inputs								
SLASEL	I2C slave address select								
AFEN	CEN chip enable active high on VCM driver IC								
MIPI Interface									
MDN0	DN0	MD0N	DATA_N	DMO1N	MIPI 1st data lane negative output				
MDP0	DP0	MD0P	DATA_P	DMO1P	MIPI 1st data lane positive output				
MDN1	DN1	MD1N	DATA2_N	DMO2N	MIPI 2nd data lane negative output				
MDP1	DP1	MD1P	DATA2_P	DMO2P	MIPI 2nd data lane positive output				
MDN2	DN2	MD2N	DATA3_N	DMO3N	MIPI 3rd data lane negative output				
MDP2	DP2	MD2P	DATA3_P	DMO3P	MIPI 3rd data lane positive output				
MDN3	DN3	MD3N	DATA4_N	DMO4N	MIPI 4th data lane negative output				
MDP3	DP3	MD3P	DATA4_P	DMO4P	MIPI 4th data lane positive output				
MCN	CLKN	CLK_N	DCKN	MIPI clock negative output					
MCP	CLKP	MCP	CLK_P	DCKN	MIPI clock positive output				
DVP Parallel Interface									
D0	DO0	Y0	DVP data output port 0						
D1	DO1	Y1	DVP data output port 1						
D2	DO2	Y2	DVP data output port 2						
D3	DO3	Y3	DVP data output port 3						
D4	DO4	Y4	DVP data output port 4						
D5	DO5	Y5	DVP data output port 5						
D6	DO6	Y6	DVP data output port 6						
D7	DO7	Y7	DVP data output port 7						
D8	DO8	Y8	DVP data output port 8						
D9	DO9	Y9	DVP data output port 9						
D10	DO10	Y10	DVP data output port 10						
D11	DO11	Y11	DVP data output port 11						

www.YDSCAM.com sales@ydscam.com Phone (WeChat, QQ): (+86) 177 2732 6718

All rights reserved @ YingDeShun Co. Ltd. Specifications subject to change without notice.

Camera Reliability Test

Reliability Inspection Item		Testing Method	Acceptance Criteria	
Category	Item			
Environmental	Storage Temperature	High 60°C 96 Hours	Temperature Chamber	No Abnormal Situation
		Low -20°C 96 Hours	Temperature Chamber	No Abnormal Situation
	Operation Temperature	High 60°C 24 Hours	Temperature Chamber	No Abnormal Situation
		Low -20°C 24 Hours	Temperature Chamber	No Abnormal Situation
	Humidity	60°C 80% 24 Hours	Temperature Chamber	No Abnormal Situation
	Thermal Shock	High 60°C 0.5 Hours Low -20°C 0.5 Hours Cycling in 24 Hours	Temperature Chamber	No Abnormal Situation
Physical	Drop Test (Free Falling)	Without Package 60cm	10 Times on Wood Floor	Electrically Functional
		With Package 60cm	10 Times on Wood Floor	Electrically Functional
	Vibration Test	50Hz X-Axis 2mm 30min	Vibration Table	Electrically Functional
		50Hz Y-Axis 2mm 30min	Vibration Table	Electrically Functional
		50Hz Z-Axis 2mm 30min	Vibration Table	Electrically Functional
	Cable Tensile Strength Test	Loading Weight 4 kg 60 Seconds Cycling in 24 Hours	Tensile Testing Machine	Electrically Functional
Electrical	ESD Test	Contact Discharge 2 KV	ESD Testing Machine	Electrically Functional
		Air Discharge 4 KV	ESD Testing Machine	Electrically Functional
	Aging Test	On/Off 30 Seconds Cycling in 24 Hours	Power Switch	Electrically Functional
	USB Connector	On/Off 250 Times	Plug and Unplug	Electrically Functional



Camera Inspection Standard

Inspection Item		Inspection Method	Standard of Inspection		
Category	Item				
Appearance	FPC/ PCB	Color	The Naked Eye	Major Difference is Not Allowed.	
		Be Torn/Chopped	The Naked Eye	Copper Crack Exposure is Not Allowed.	
		Marking	The Naked Eye	Clear, Recognizable (Within 30cm Distance)	
	Holder	Scratches	The Naked Eye	The Inside Crack Exposure is Not Allowed	
		Gap	The Naked Eye	Meet the Height Standard	
		Screw	The Naked Eye	Make Sure Screws Are Presented (If Any)	
		Damage	The Naked Eye	The Inside Crack Exposure is Not Allowed	
	Lens	Scratch	The Naked Eye	No Effect On Resolution Standard	
		Contamination	The Naked Eye	No Effect On Resolution Standard	
		Oil Film	The Naked Eye	No Effect On Resolution Standard	
		Cover Tape	The Naked Eye	No Issue On Appearance.	
	Function	Image	No Communication	Test Board	Not Allowed
			Bright Pixel	Black Board	Not Allowed In the Image Center
Dark Pixel			White board	Not Allowed In the Image Center	
Blurry			The Naked Eye	Not Allowed	
No Image			The Naked Eye	Not Allowed	
Vertical Line			The Naked Eye	Not Allowed	
Horizontal Line			The Naked Eye	Not Allowed	
Light Leakage			The Naked Eye	Not Allowed	
Blinking Image			The Naked Eye	Not Allowed	
Bruise			Inspection Jig	Not Allowed	
Resolution			Chart	Follows Outgoing Inspection Chart Standard	
Color			The Naked Eye	No Issue	
Noise			The Naked Eye	Not Allowed	
Corner Dark			The Naked Eye	Less Than 100px By 100px	
Color Resolution			The Naked Eye	No Issue	
Dimension	Height	The Naked Eye	Follows Approval Data Sheet		
	Width	The Naked Eye	Follows Approval Data Sheet		
	Length	The Naked Eye	Follows Approval Data Sheet		
	Overall	The Naked Eye	Follows Approval Data Sheet		

YDSCAM Package Solutions

YDS Camera Module



Complete with Lens Protection Film



Tray with Grid and Space



Place Cameras on the Tray

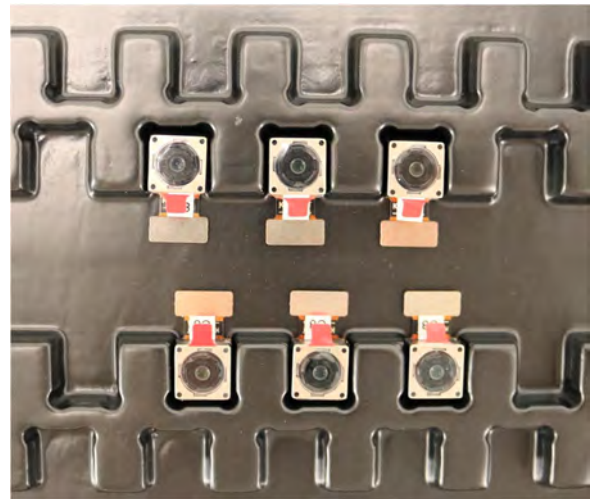

YDSCAM Package Solutions

Full Tray of Cameras

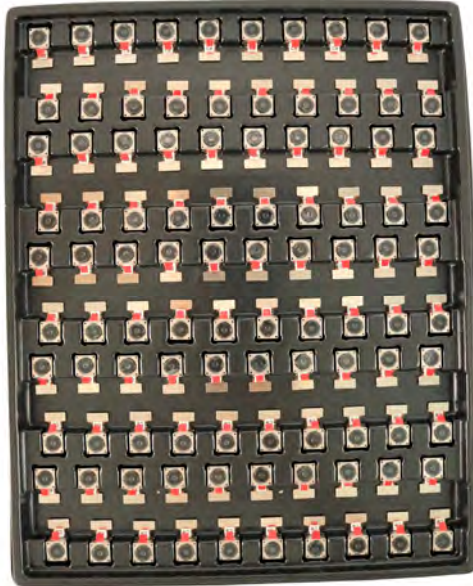

Cover Tray with Lid

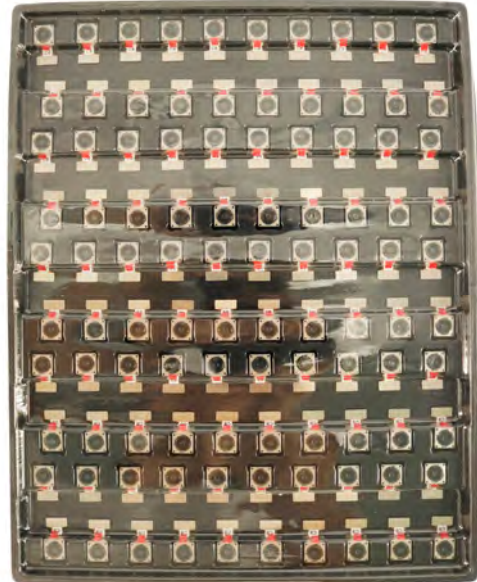

Place Tray into Anti-Static Bag



Vacuum the Anti-Static Bag



YDSCAM Package Solutions

Sealed Vacuum Anti-Static Bag with Labels

1. Model and Description 2. Quantity 3. Manufacturing Date Code 4. Caution



YDSCAM Package Solutions

Place Foam Sheets Between Tray Bags



Foam Sheets are Larger Than Trays



Place Foam Sheets and Trays into Box



Foam Sheets are Tightly Fitting in Box



Seal the Carbon Box



Label the Carbon Shipping Box





YDSCAM Package Solutions

USB Camera Module

Complete with Lens Protection Film



Place Camera Sample into Anti-Static Bag

Place USB Cameras into Tray



Seal the Tray with Anti-Static Bag

Label the Carbon Shipping Box



YDSCAM Package Solutions

Place Camera Sample into Anti-Static Bag



Place Connectors into Anti-Static Bag



Label the Sample Bags



Place Connectors into Reel



Place Samples into the Carbon Box



Place Connectors into the Carbon Box





YDS CAMERA MODULE

your best camera partner

Company YDSCAM

YingDeShun Co. Ltd. (YDS) was established in 2017, a next-generation technology driven manufacturer specialized in research, design, and produce of audio and video products. YDS is occupying 20,000 square feet automated plants with 100 employees of annual throughput 30,000,000 units cameras.

YDS provides OEM, ODM design, contract manufacturing, and builds the camera products. You may provide the requirements to us, even with a hand draft, our sales and engineering work together to meet your needs. We consider ourselves your last-term partner in developing practical and innovative solutions.

Our team covers everything from initial concept development to mass produced product. YDS specializes in customized camera design, raw material, electronic engineering, firmware/software development, product testing, and packing design. Our experienced strategic supply systems offer a robust and dependable manufacturing capacity for orders of various sizes.

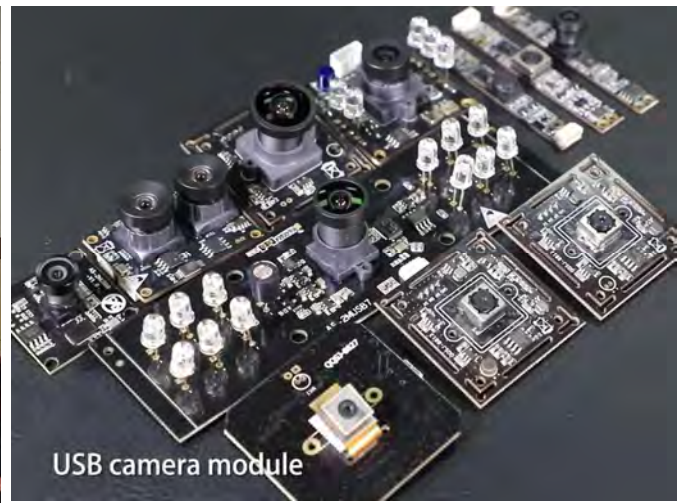

Limited Warranty

YDS provides the following limited warranty if you purchased the Product(s) directly from YDS company or from YDS's website www.YDSCAM.com. Product(s) purchased from other sellers or sources are not covered by this Limited Warranty. YDS guarantees that the Product(s) will be free from defects in materials and workmanship under normal use for a period of one (1) year from the date you receive the product ("Warranty Period").

For all Product(s) that contain or develop material defects in materials or workmanship during the Warranty Period, YDS will, at its sole option, either: (i) repair the Product(s); (ii) replace the Product(s) with a new or refurbished Product(s) (replacement Product(s) being of identical model or functional equivalent); or (iii) provide you a refund of the price you paid for the Product(s).

This Limited Warranty of YDS is solely limited to repair and/or replacement on the terms set forth above. YDS is not reliable or responsible for any subsequent events.



www.YDSCAM.com sales@ydscam.com Phone (WeChat, QQ): (+86) 177 2732 6718

All rights reserved @ YingDeShun Co. Ltd. Specifications subject to change without notice.



YDS CAMERA MODULE

your best camera partner

YDS Strength

Powerful Factory



Professional Service



Promised Delivery



www.YDSCAM.com sales@ydscam.com Phone (WeChat, QQ): (+86) 177 2732 6718

All rights reserved @ YingDeShun Co. Ltd. Specifications subject to change without notice.